

LWAE-250 Series

Product Characteristic

- Material: PA66
- Type of protection: IP55
- Insulation class: B
- Motor type: BLEC Motor
- Operation Temperature: -25 C ~ +60 C
- Technical Feature: Control input 0-10VDC/PWM, Tech output, Locked-Rotor protection, Reverse Polarity Over-voltage protection, Soft Start Protection.



Technical Specifications

Model	Voltage (V)	Frequency (Hz)	Current (A)	Power [W(@0Pa)]	Speed (RPM)	Air Volume (m³/h)	Noise [dB(A)]
LWAE3G250SS-7PNW-07	220	50/60	0.61	85	2480	1627	60
LWAE3G250SS-7PKW-08	220	50/60	0.61	85	2480	1627	60

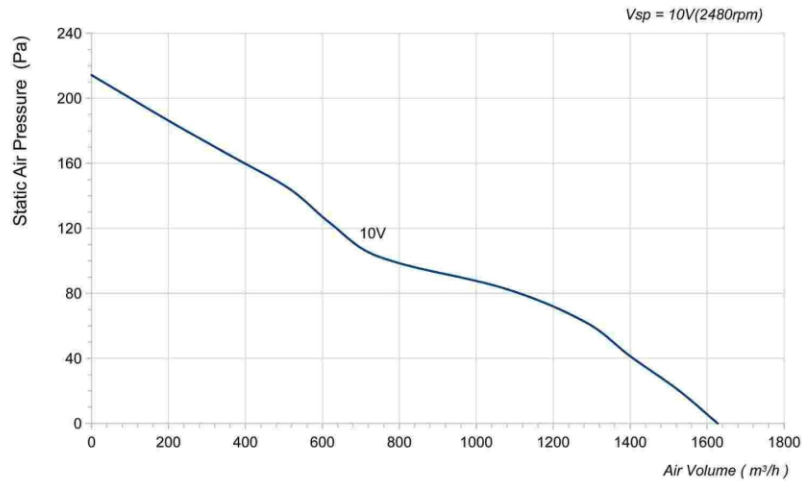

LWAE3G250SS-7PNW-07

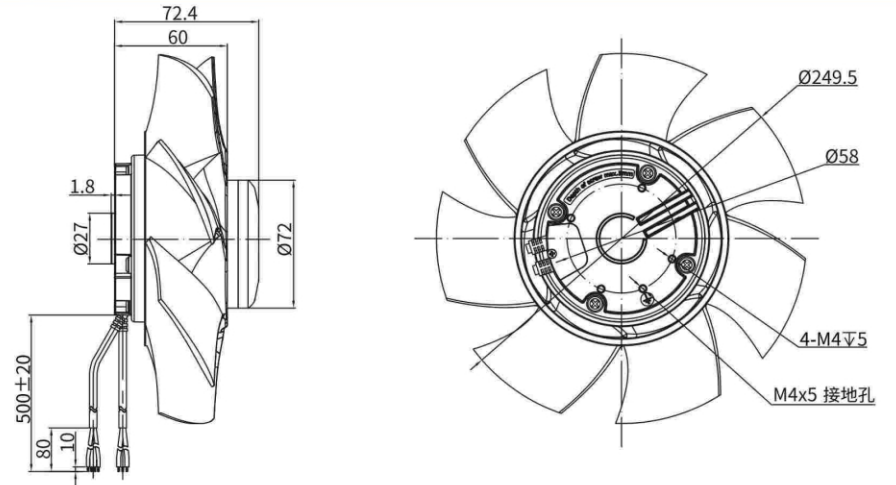

LWAE3G250SS-7PKW-08

