

LWAE-200 Series

Product Characteristic

- Material: PA66
- Type of protection: IP55
- Insulation class: B
- Motor type: BLEC Motor
- Operation Temperature: -25 C ~ +60 C
- Technical Feature: Control input 0-10VDC/PWM, Tech output, Locked-Rotor protection, Reverse Polarity Over-voltage protection, Soft Start Protection.



Technical Specifications

Model	Voltage (V)	Frequency (Hz)	Current (A)	Power [W(@0Pa)]	Speed (RPM)	Air Volume (m³/h)	Noise [dB(A)]
LWAE3G200SS-7PNW-13	220	50/60	0.4	55	2780	1009	60
LWAE3G200SS-7PKW-14	220	50/60	0.4	55	2780	1009	60

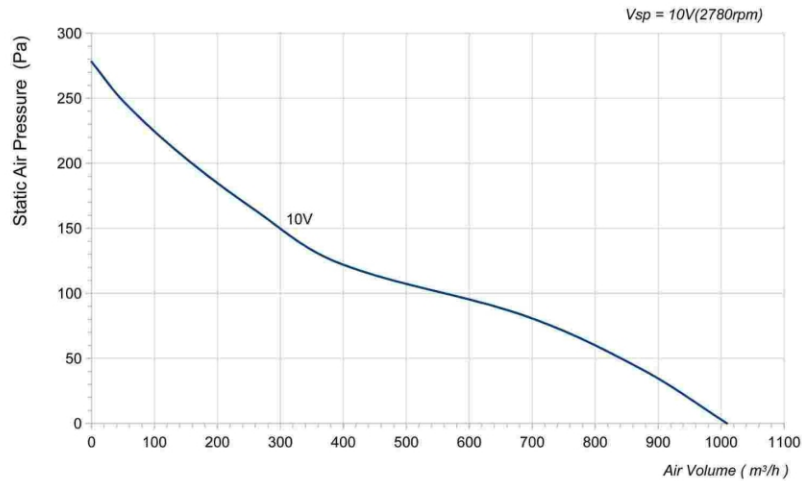

LWAE3G200SS-7PNW-13

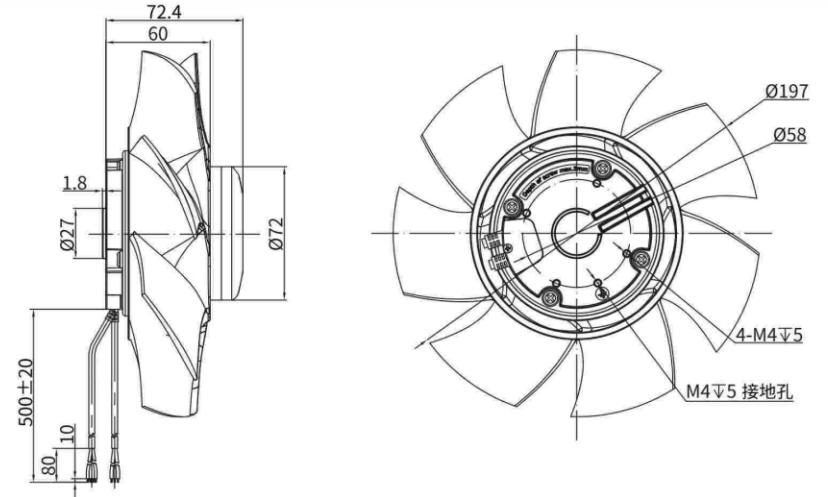

LWAE3G200SS-7PKW-14

