

LWBE-630 Series

Product Characteristic

- Impeller Material: Aluminum Alloy
- Supply Voltage: 400V,50/60Hz
- Mode Of Operation: S1
- Protection Class: IP54
- Insulation Class: F
- Operation Temperature: -25℃ ~ +60℃
- Technical Feature: Control input 0-10VDC/PWM, Tech output, Locked-Rotor protection, Reverse Polarity Over-voltage protection, Soft Start Protection.



Technical Specifications

Model	Voltage (V)	Input Power (W)	Current (A)	Air Volume (m³/h)	Static Pressure (Pa)	Speed (RPM)	Noise [dB(A)]
LWBE3G630-188PT-04	400	5570	10.8	21742	1677	1760	/

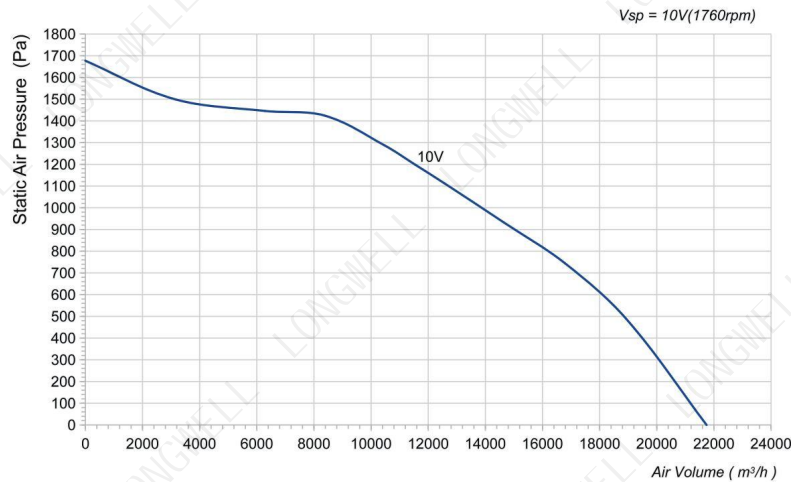

LWBE3G630-188NT-09 (without bracket)

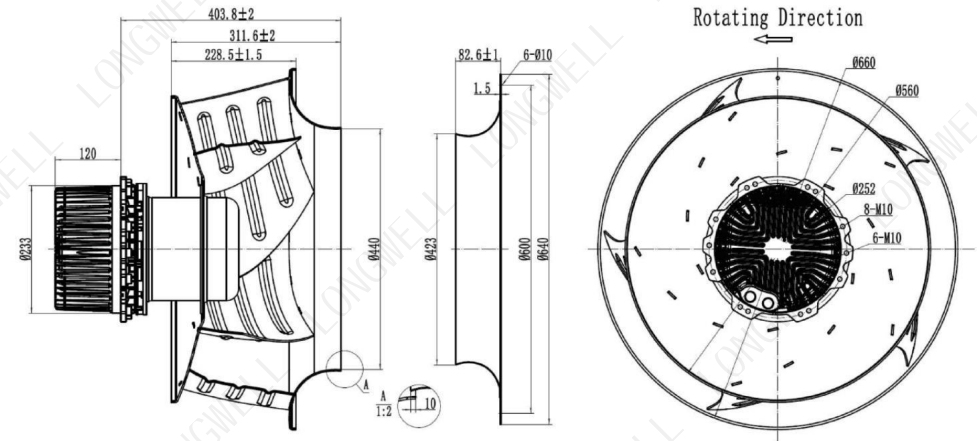

LWBE3G630-188PT-04 (with bracket)

