

LWBE-355 Series

Product Characteristic

- Impeller Material: Aluminum Alloy
- Supply Voltage: 230V,50/60Hz
- Mode Of Operation: S1
- Protection Class: IP55
- Insulation Class: F
- Operation Temperature: -25°C ~ +60°C
- Technical Feature: Control input 0-10VDC/PWM, Tech output, Locked-Rotor protection, Reverse Polarity Over-voltage protection, Soft Start Protection.



Technical Specifications

Model	Voltage (V)	Input Power (W)	Current (A)	Air Volume (m³/h)	Static Pressure (Pa)	Speed (RPM)	Noise [dB(A)]
LWBE3G355-102PS-09	230	520	3.1	4172	906	2550	75

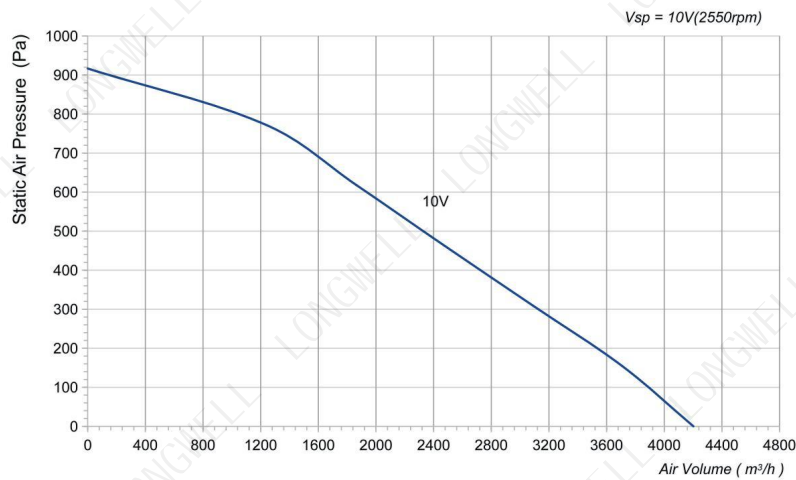

LWBE3G355-102NS-24 (without bracket)

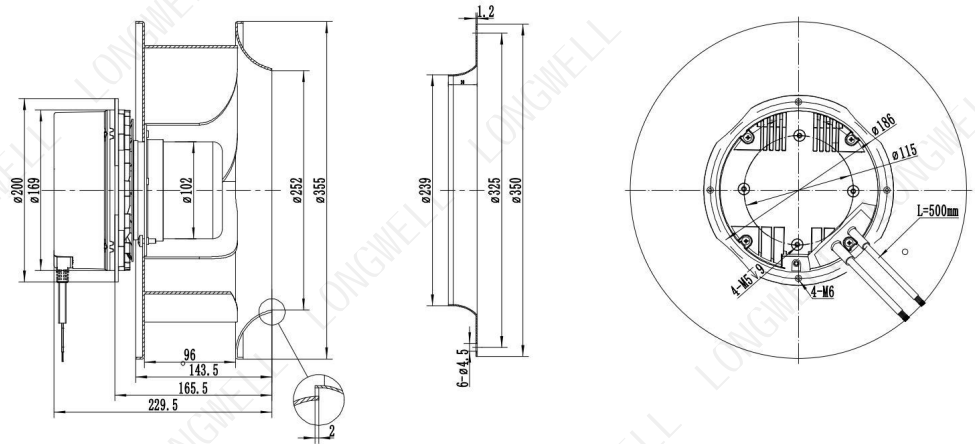

LWBE3G355-102PS-09 (with bracket)

