

LWBE-225 Series

Product Characteristic

- Impeller Material: PA6+GF
- Supply Voltage: 230V,50/60Hz
- Direction of rotation: Clockwise,seen on rotor
- Mode Of Operation: S1
- Protection Class: IP55
- Insulation Class: F
- Mounting position: Horizontal or Vertical
- Operation Temperature: -25 C ~ +60 C
- Bearing: Maintenance-free ball bearings
- Technical features: Control input 0-10VDC/PWM
- Protection: Tech output,Locked-Rotor protection
Reverse Polarity,Over-voltage protection,Soft Start



Technical Specifications

Model	Voltage (V)	Input Power (W)	Current (A)	Air Volume (m³/h)	Static Pressure (Pa)	Speed (RPM)	Noise [dB(A)]
LWBE3G225-072NS-11	230	85	0.7	1009	618	2300	65

Product Drawing (mm)

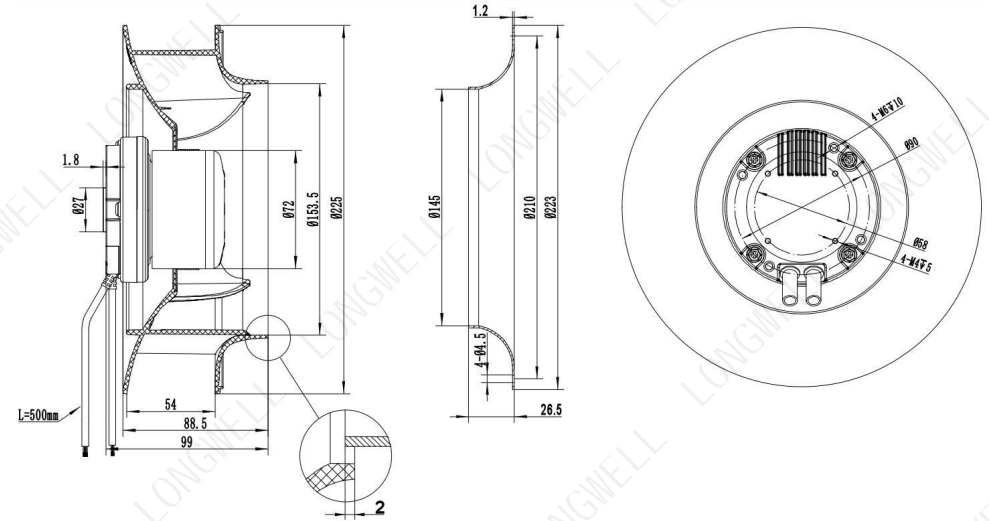

Flow Rate Curve

