

# AXIAL FAN - AC

LWAA400S-5

230V~50/60Hz

Ningbo Longwell Electric Technology CO.,LTD

Yuyao,Zhejiang Province,China 315400

Phone 86 574 6218 9863

Fax 86 574 6218 9863

sales@zjlongwell.com

www.longwellfans.com



## Nominal Data

Model No.		LWAA4E400S-5MEB-09	LWAA4E400S-5MEB-10
Nominal Voltage :	[VAC]	230	
Voltage Range :	[VAC]	198~242	
Frequency :	[Hz]	50	60
Speed :	[rpm]	1350	1600
Current :	[A]	1.1	1.2
Power input :	[W]	230	280
Air flow (Max) :	[m3/h]	4532	5150
	[CFM]	2666	3030
Capacitor :	[uF]	7	7
Noise level :	dB(A)	62	64
Min.ambient Temp :	°C	-30	
Max.ambient Temp :	°C	+ 60	

# AXIAL FAN - AC

LWAA400S-5

230V~50/60Hz

## Technical Features

Material	Cold-rolled sheet ( Impeller )
Life Expectance	30,000Hours(L10), At normal supply voltage , 20°C room with full speed, humidity 15%~65%RH.
Service environment	Operating temperature: -30~+60°C; Operating humidity: 0 ~ 95 % RH Storing temperature: -40 ~ 80°C; Storing humidity: 0 ~ 75 % RH Applicable altitude range: < 1000m
Insulation Class	Class F (155°C)
Protection Type	IP54
Production standard	GB12350 《Safety requirements of small power motors》 JB/T10562 《 Technical specification for general purposes axial fans》 EN60335-1 《Household and similar electrical appliances-safety》 ISO5801-1997 《Industrial fans-performance testing using standardized airways》 GB/T2888 《 Methods of Noise Measurement for Fans Blowers Compressors and Roots Blowers》
Balancing	At the rated voltage and frequency,the residual unbalance of the fan is not less than G6.3 (balancing precision grade)in each plane,according with JB/T9101
Vibration of the fan	Vibration speed virtual value of fans accord with JB/T8689
Thermal protection function	This motor with heat protection,cut off temperature:150-160°C,replacement temperature 100~130°C

# AXIAL FAN - AC

LWAA400S-5

230V~50/60Hz

## Product Drawing

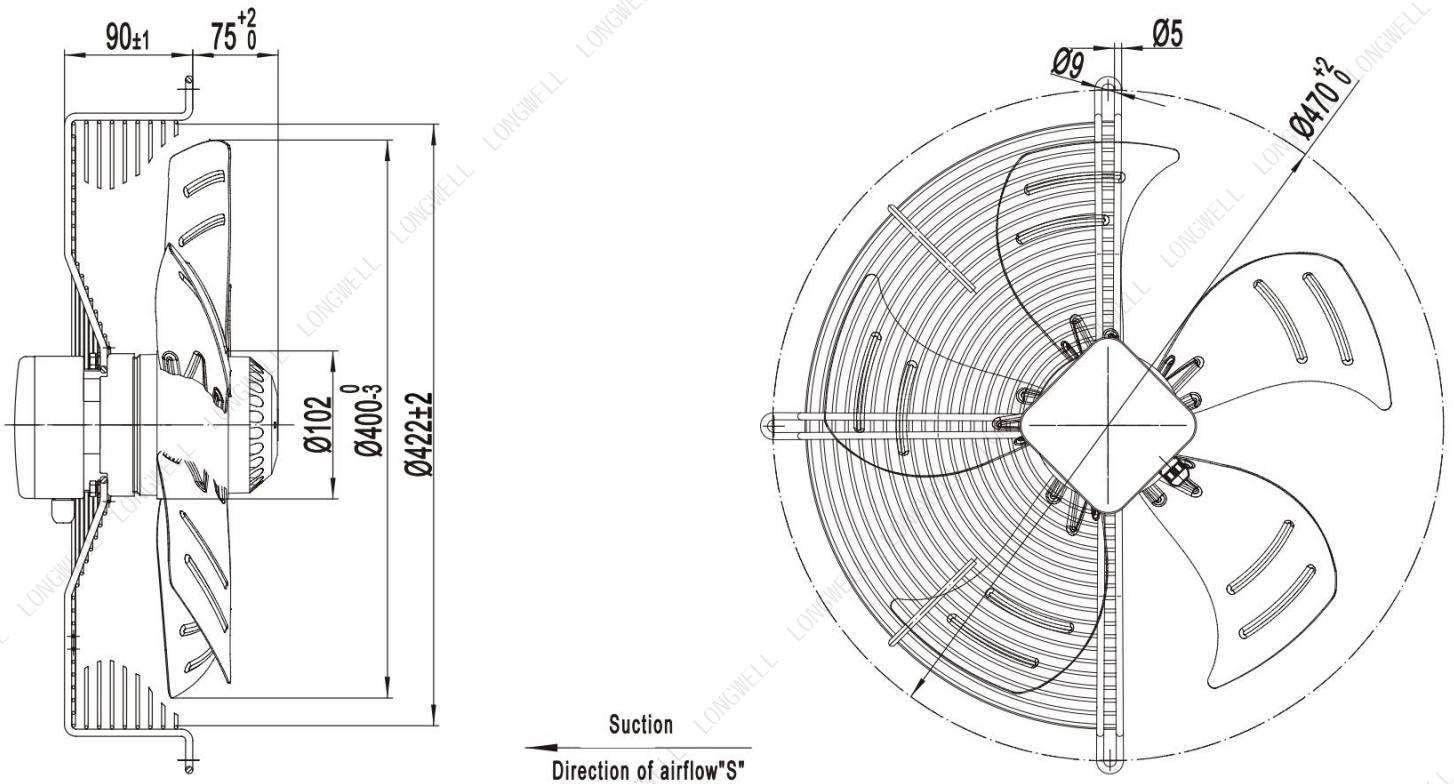

# AXIAL FAN - AC

LWAA400S-5

230V~50/60Hz

## Charts :Air Flow

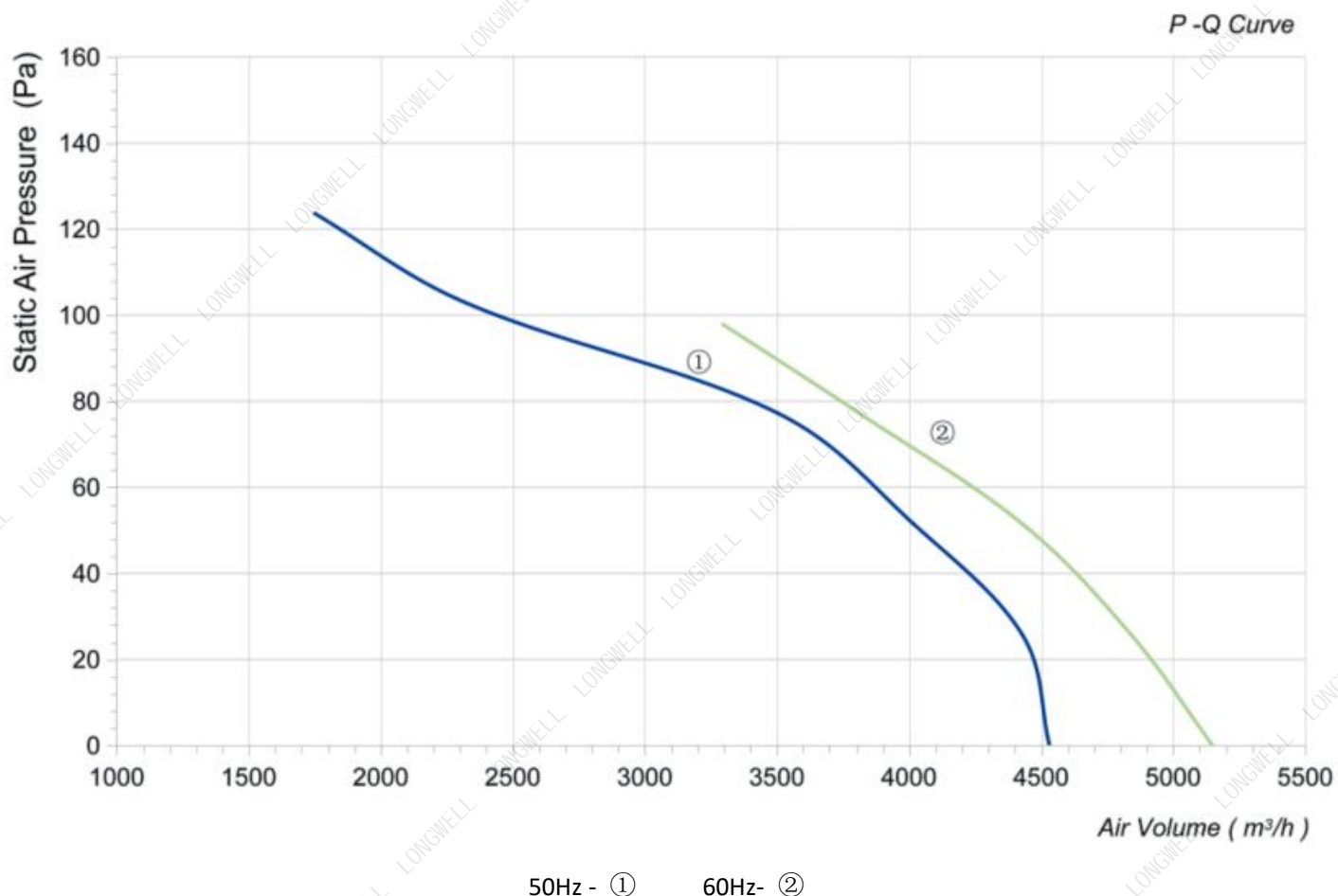

# AXIAL FAN - AC

LWAA400S-5

230V~50/60Hz

## Wiring Diagram

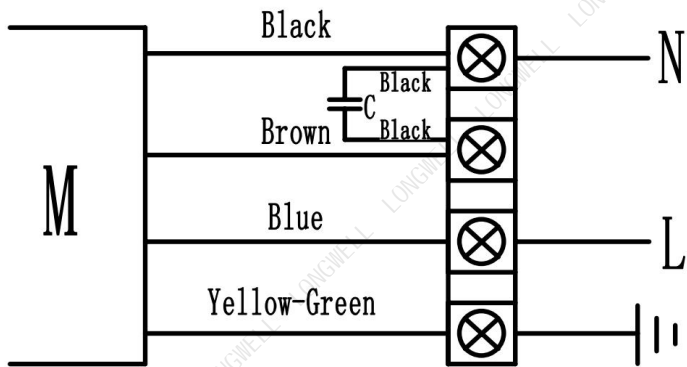

## Label

Confirm by sales team when placing sample order or bulk order

# AXIAL FAN - AC

LWAA400S-5

230V~50/60Hz

## 警示语 : Warning

1. 电机、风机必须在规定的温度和湿度范围内使用，否则可能造成不可预测的损坏。

The fan and motor must be used within the prescribed scope of temperature and humidity otherwise it will cause an unexpected damage.

2. 请务必使用铭牌指示的正确电压接入产品，否则会造成风机损坏。

Provide the right voltage according to the nameplate otherwise it will damage the product.

3. 电机接线必须按接线图的指示，有接地线要求的产品请务必接上地线，不建议客户使用延长线，所有不按指示接线都可能造成电机烧坏。

Wiring depends on the wiring diagram and please connect the earth ground if required. We don't suggest to use the extension cord .Any wrong connection may cause the damage of the fan.

4. 在移动产品的时候，不得以风机扇叶为受力点搬运产品，否则会造成扇叶变形而使风机运转时震动过大。

Be careful when moving the fan and do not take the blades as a handle because it will cause the distortion and chatter.

5. 对于有接温控器要求的风机，请务必连接带温控器的引线，否则有可能造成电机内部温度过高而损坏。

Connect the thermostat if required otherwise it would damage the motor because of the over temperature.

6. 使用的安装螺丝不得超过要求长度，否则会造成风机损坏。

The length of the mounting screws shall not exceed the requirement, otherwise the fan will be damaged.

7. 请不要自主拆装风机，否则将影响扇叶平衡、防水等效果，严重的将引起安全问题。

Do not disassemble the fan arbitrarily. It may hurt the capacity of water tightness and dynamic balance or cause other serious problems.

8. 风机的电气连接必须有合适的过流保护器以防止电流过大对产品造成损坏。

The over current protector is necessary in case the damage from the over current.

9. 请按风机的建议安装方向安装产品，任何不按产品的要求来安装将会影响风机的使用寿命。

Install the fan as required, any other installing direction would affect the service life of the product.

10. 配置导风圈的风机需按照推荐尺寸设计和安装，否则将影响产品性能。

The fan with inlet ring should be installed follow the requirements or it will affect the performance.

11. 对于未带电缆线之风机，客户所接电缆线的线径需在要求的范围内，否则将影响防水效果。

Users should use the standard cable when install the fan otherwise it will affect the water tightness.

12. 风机请安装在儿童不能接触到扇叶和带电的地方，也不允许儿童单独使用本产品。

The fan should keep away from the children especially the blade and electric parts .And the children are not allowed to operate the fan alone.

未按以上条例安装及使用风机，所造成的机器损坏或者事故，我公司均不承担任何责任。敬请知悉！

Please be informed that we are not responsible for any damage or accidents caused by violating above rules to install and operate the fan

AXIAL FAN - AC

LWAA400S-5

230V~50/60Hz

**CUSTOMER APPROVAL**

**CUSTOMER SIGNATURE:**

**DATE :**

**Product Data Confirm :**